



VDR &
Servicii SRL



Alexandru BURTICĂ, Sales & Technical Manager PILZ

Cristian MODRESCU, Product Manager BÜRKERT, AKO, SCHUBERT-SALZER



SISTEME DE SIGURANTA

APLICATII INDUSTRIALE

pilz



CE ESTE SAFETY / SIGURANTA?

SAFETY/ SIGURANTA INSEAMNA:

- ✓ LIPSA PERICOLULUI
- ✓ UTILAJE SECURIZATE
- ✓ ANALIZA, EVALUAREA SI REDUCEREA RISCULUI
- ✓ UTILIZAREA SISTEMELOR DE SIGURANTA

Punctul de pornire pentru
Analiza riscului a unui
Sistem de control de
siguranta

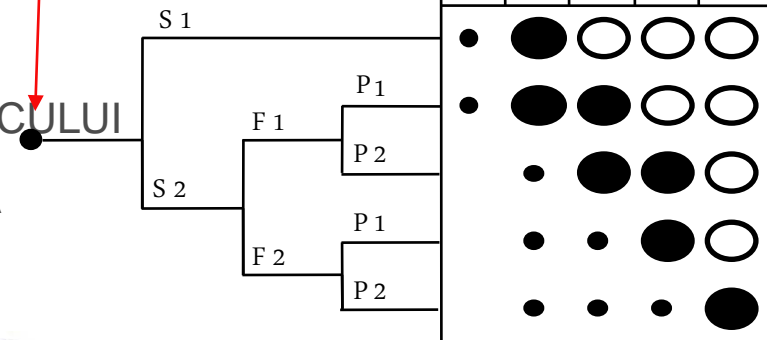

COSTUL TOTAL AL UNUI ACCIDENT :

- 10% este vizibil
- 90% este invizibil

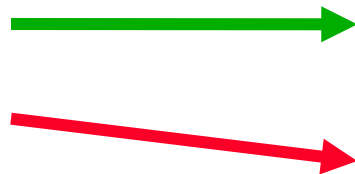

STANDARDE EUROPENE, INTERNATIONALE, NATIONALE (HG)



- EN ISO 13849
- EN IEC 62061
- EN 954-1
- DIRECTIVA MASINILOR 98/37/EC
- MARCAJUL CE

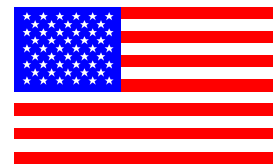

SISTEME DE SAFETY / SIGURANTA

pilz
more than automation
safe automation

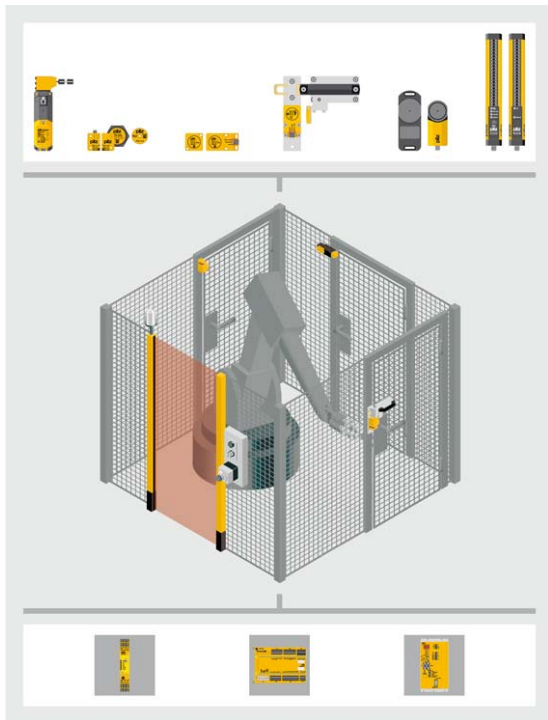

Senzori optici de siguranta

Porti de siguranta

Paravane de siguranta

Butoane de urgenta

Butoane de control bimanual



PSEN - SENZORI

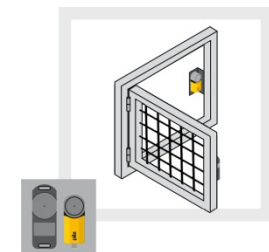

SISTEME DE SAFETY / SIGURANTA

- ❑ Relee de siguranta
- ❑ Relee de monitorizare
- ❑ Sisteme de control si comunicatii
- ❑ Sisteme de operare si monitorizare

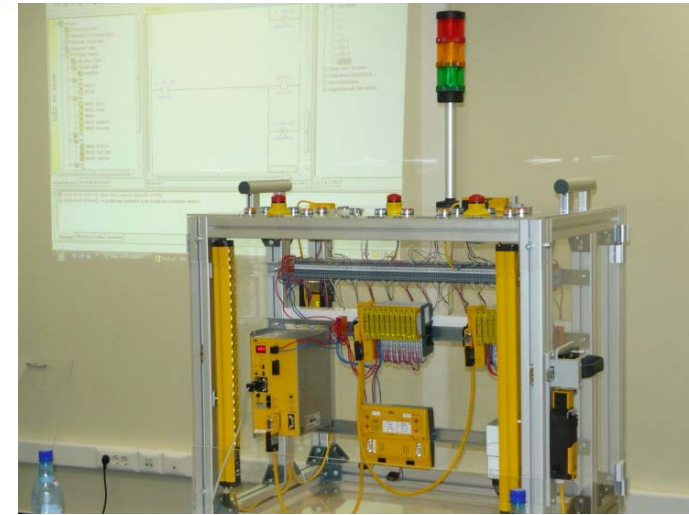

PNOZ RELEU



PNOZmulti CONTROLLER



PSS- SISTEM PROGRAMABIL

CE VETI PUTEA INVATA :

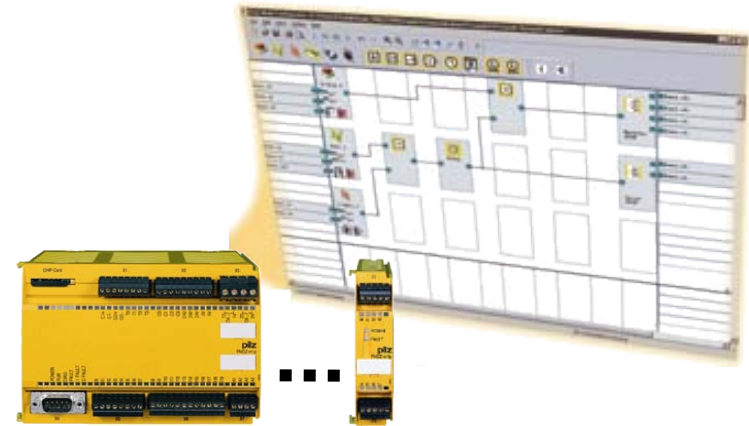
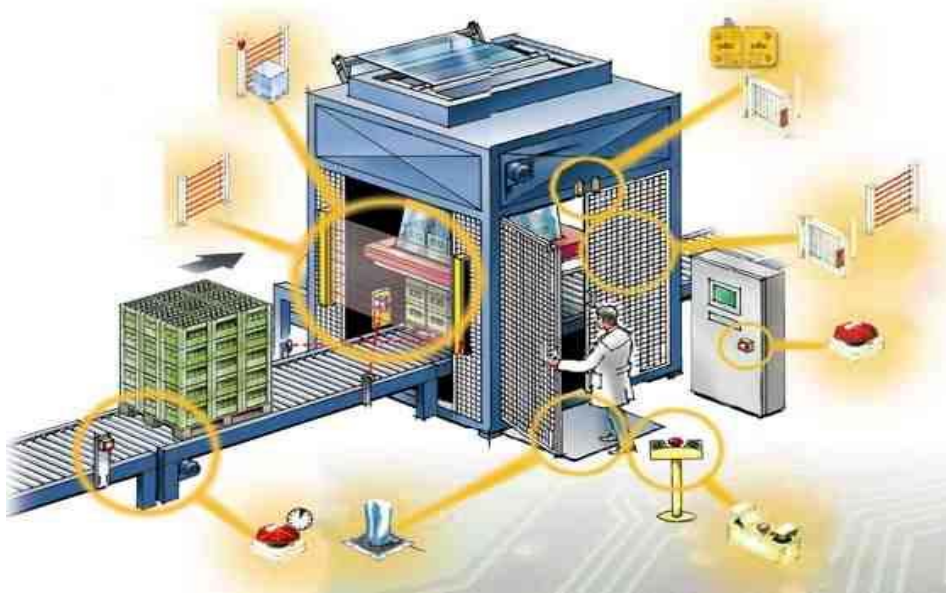

PNOZmulti sistem de siguranta modular



PNOZ rele de siguranta

Sistem programabil
de siguranta PSS

AUTOMATIZARI DE SIGURANTA APLICATII

pilz
more than automation
safe automation

- **Automotive**
- **Otel si aluminiu**
- **Hartie & servetele**
- **Ambalare bunuri de consum**
- **Alimente & Bauturi**
- **Farmacie**
- **Constructii**
- **Energie**
- **Transport & Logistica**

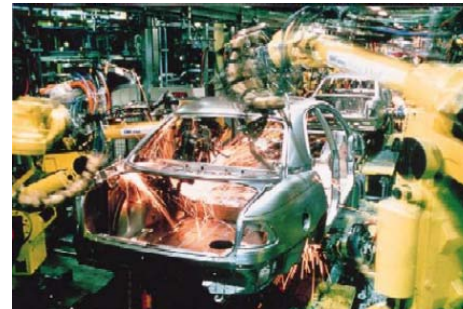



MANAGEMENTUL FLUIDELOR IN APLICATII INDUSTRIALE



... simply innovative!

Categorii de produse

- **Electroventile**
- **Ventile de proces**
- **Valve de reglaj**
- **Senzori, traductoare si controlere**

bürkert
FLUID CONTROL SYSTEMS

Segmente Bürkert

Water Treatment



Hygienic Processing



Gas Handling



MicroFluidics

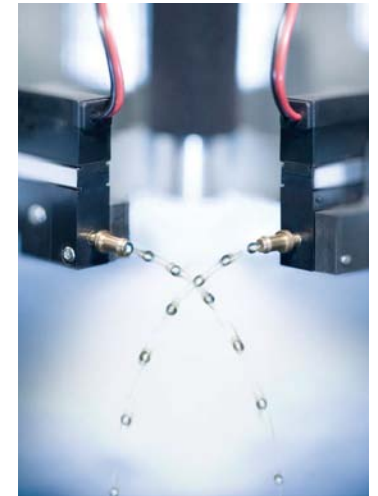

Prelucrarea fluidelor in mediu igienic

- **Produse alimentare**
- **Produse farmaceutice**
- **Cosmetice**
- **Bio - tehnologie**
- **Produse chimice fine**



MicroFluide

- Diagnostic clinic
- Laboratoare de cercetare stiintifica
- Instrumente medicale
- Tehnologie pentru Terapie Intensiva
- Analiza automatizata
- Aplicatii industriale

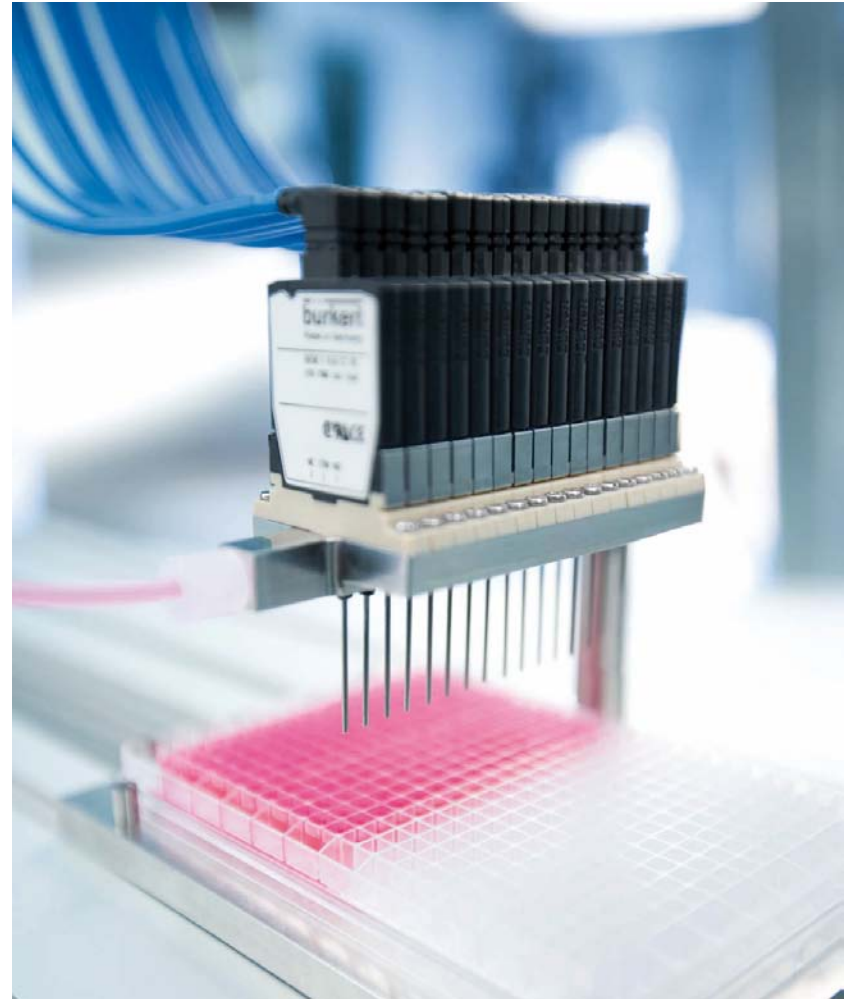

Tratarea apei

- **Tablouri de comanda**
- **Senzori analitici**
- **Masurare presiune, nivel, temperatura, debit lichide**
- **Sisteme de achizitii multi-canal**
- **Transmiterea semnalelor la distanta (sisteme CLOUD)**



Controlul gazelor

- Optimizarea debitului și a presiunii gazelor
- Controlul amestecurilor de gaze
 - Tratarea suprafețelor
 - Acoperiri metalice
 - Sudura
 - Echipamente de tăiere
 - Aplicații medicale





SCHUBERT & SALZER
CONTROL
SYSTEMS

passion for
perfection

Valve de reglaj

Valve On/Off



Valve sector bila

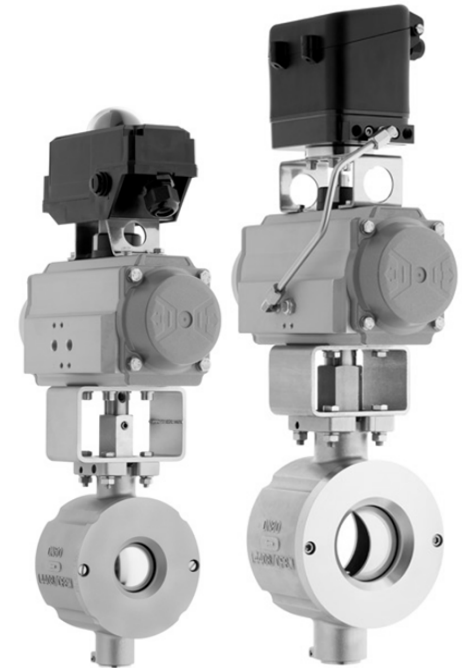

Valve sanitare



Pozitionere si controllere



Productia de anvelope



Construcția de nave – controlul combustibilului



Fantani arteziene



VALVE CU MANSON



...simply innovative!



VALVE PNEUMATICE

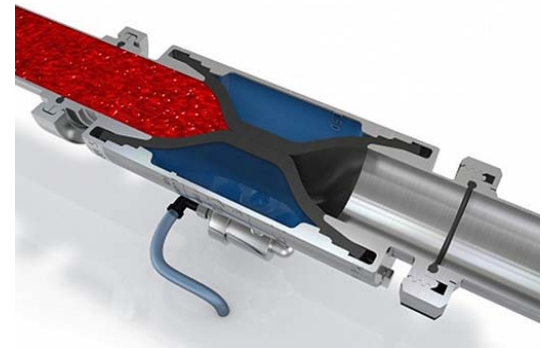

VALVE MECANICE



Industria vinului / Industria berii



BENZINARIII – ASPIRATOR CU AUTOSERVIRE



TOALETE CU VACUUM (trenuri, avioane)



Tratarea apelor uzate



VOPSITORIE IN CAMP ELECTROSTATIC



Doar pentru
optimisti 😊



VDR &
Servicii SRL

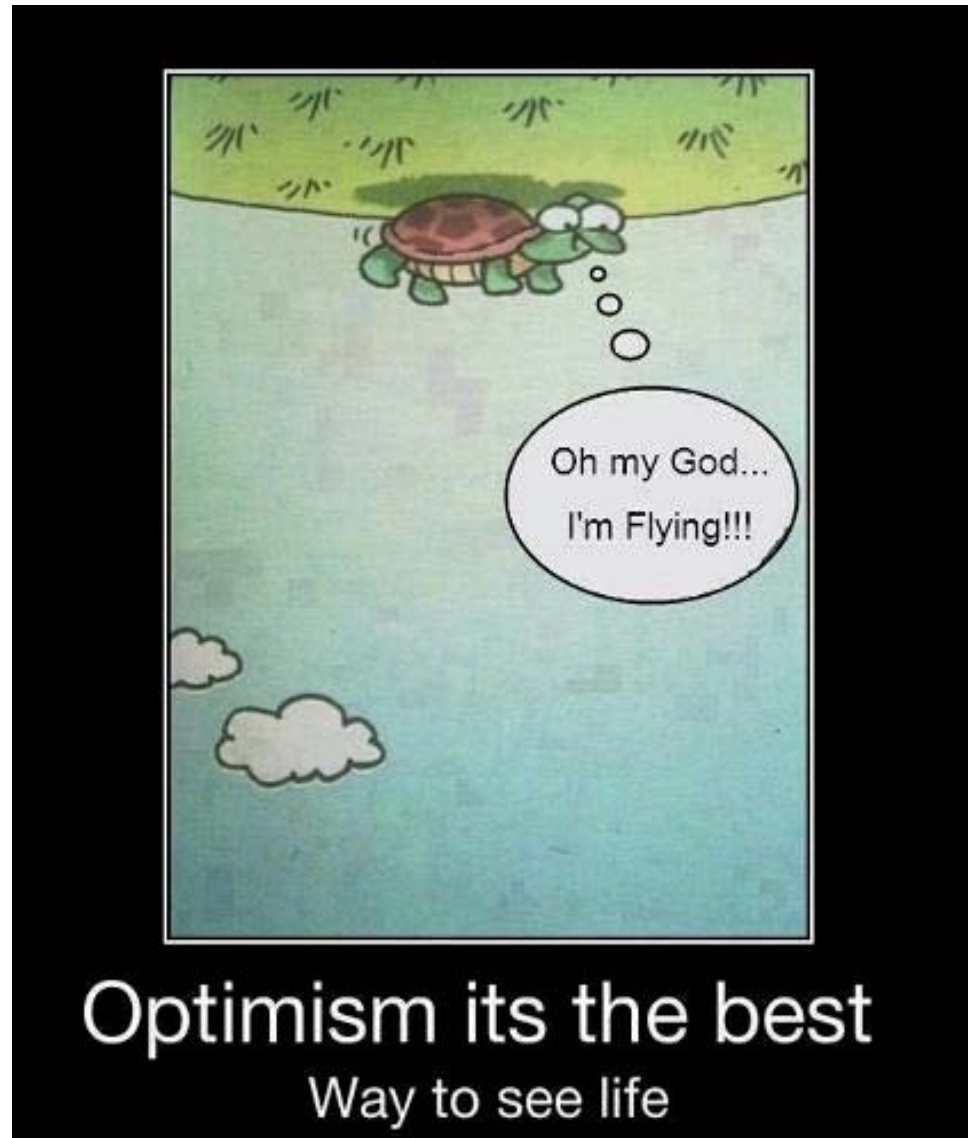



VDR &
Servicii SRL

FII UNUL DINTRE NOI !

